Examine the individual's behavioural intentions to use Green Information technology: Moderating role of personality trait conscientiousness

DR. ATIF ALI GILL¹, RIAZ HUSSAIN ANSARI¹, SAMEERA IQBAL², JAMIL ASIM³

¹Faculty department of business administration, university of Sahiwal

²Faculty Higher Colleges of technology, UAE

³PhD Scholar, Universiti of Malaysia, Sarawak

Email:atifali@uosahiwal.edu.pk,riazhussain@uosahiwal.edu.pk,sameeraiqbal786@hotmail.com,jamil.asim@uo.edu.pk

Abstract:The enormous rise in information technology (IT) usage has benefited human in numerous ways in recent years. Meanwhile, it also increases power consumption that deleteriously affects the natural resources. Environmental awareness focuses on the utilization of green Information technology (GIT) among consumers. The current article aims to examine the behaviour to use GIT based on planned behaviour theory (TPB). The data collected from university students who were familiar with GIT. Personality trait conscientiousness included as a moderator in the research model. The findings through the statistical technique of partial least square structural equation modelling (PLS-SEM) revealed that green attitude, subjective norm, and perceived behaviour control significantly impact the intention to use GIT. While conscientiousness significantly moderates the relationships between green attitude and intention to use GIT. The present study provides several implications by extending the TPB theory through the moderating effect of conscientiousness and further delivering guidelines to policymakers in higher education institutes to improve students' personality traits for better intention towards using green information technology.

Keywords: Green Information Technology, Theory of planned behaviour, Intention to use, Higher education institutes, Developing country

INTRODUCTION

Green information technology (GIT) has become a global phenomenon, and many organizations update their policies that show their concerns toward environmental degradation (Dalvi-Esfahani et al., 2020). Rapid development in technology brings natural hazards like carbon emission, emission of green gases, additional usage of electricity that causes depletion of natural resources (Nizam et al., 2020). The eco-sustainability is affected by the rise in information technology (IT) usage. The expenditures on technology infrastructure and IT usage contribute to additional power requirements that consume scarce natural resources (Li et al., 2020).

Green policies need to implement in organizations to offset environmental degradation through green practices like less paper usage, virtualization, less printing, enabling cloud computing, and renewable energies (A. Gill et al., 2021; Hernandez, 2020). Green practices become mandatory for a sustained healthy environment. The most essential way is increasing the level of awareness and usage of GIT in organizations. Universities use information and communication technology (ICT) in their education process to communicate with students, especially during the pandemic of COVID-19 enormous usage of ICT witness in higher education institutes (A. A. Gill et al., 2020; Lee et al., 2020).

GIT explains the disposing of IT operations in a firm through an eco-friendly manner to minimize its negative effect on the environment. GIT concerns with both process efficiency through IT artefacts and environmental sustainability. Green values and beliefs affect individual behaviour while following green practices (Al-Ghazali & Afsar, 2021). Past literature was more focused on adopting Green technology adoption at an organizational level, while there are limited studies that examine green IT adoption at the individual behavioural level (Zhang et al., 2020). Students are concerned about environmental sustainability but unaware of the behavioural aspects regarding green information technology (Dalvi-Esfahani et al., 2020).

Theory of planned behaviour (TPB) gained a lot of support from authors who conducted behavioural intention in environmental studies (Fu, 2021). Subjective Norms play an essential role in reshaping individual beliefs to execute a particular behaviour (Sethi & Jain, 2020). Green IT is less explored in developing countries (Dalvi-

Esfahani et al., 2020; Thabit et al., 2021). There is a dearth of research to examine the GIT among students at higher education institutes in third-world countries (Dalvi-Esfahani et al., 2020). Moreover, the scarcity of research integrating TPB and personality traits (Wang et al., 2020). The current study examined the moderating effect of the conscientiousness personality trait on the relationship between the green attitude, social norm, perceived behavioural control, and intention to use GIT.

The above mentioned proposed the following research questions:

Do green attitude, subjective norm, and perceived behaviour control affect intention to use GIT?

Does conscientiousness (personality trait) moderate the relationship of green attitude, social norm, and perceived behaviour control effect and intention to use GIT?

LITERATURE REVIEW

Green computing explains the usage of information technology (IT) equipment by considering environmental sustainability (Muniswamaiah et al., 2020). The IT artifacts should be energy efficient and made of recycling material (Chih-Lin et al., 2020). In this way, green IT could reduce electricity consumption and lessen carbon emissions (Shahzad et al., 2020). Students in the university use technology items daily using laptops, tablets, printers, projectors, workstations. The universities make policies to reduce electronic waste and energy affecting equipment, less paper printing (Nizam et al., 2020). The higher education institutes in Pakistan are also working on renewable energy to cut costs and save the environment. Still, there is limited research on Pakistani higher education students toward green technology usage in a campus building (Habib et al., 2021).

Theory of planned behaviour (TPB) explains the individual intention to perform an activity due to peers' pressure and societal norms that transform their beliefs to act in a certain way (Yarimoglu & Gunay, 2020). Positive feelings make attitude towards a particular phenomenon also affects the intention of an individual. An individual's control on its behaviour on occurrence leads toward increased intention that stated as Perceived behavioural control in TPB (Hagger & Hamilton, 2021). The literature mentioned above proposed the following hypotheses.

Hypothesis 1. Green attitude has significant positive influence on students' intention to use GIT.

Hypothesis 2. Subjective norm has significant positive influence on students' intention to use GIT.

Hypothesis 3. Perceived Behavioural has significant positive influence on students' intention to use GIT.

Personality trait witnessed more in information system (IS) studies that depict personality traits on usage behaviour and habit about a certain technology (Dalvi-Esfahani et al., 2020). Currently, personality trait comprises big five traits including experience, conscientiousness, extraversion, agreeableness and neuroticism where conscientiousness has been found more linked towards individual commitment towards eco-sustainability (Qazi et al., 2020).

Hypothesis 4. Conscientiousness moderates the strength of effect between green attitude and intention to use GIT.

Hypothesis 5. Conscientiousness moderates the strength of effect between subjective norm and intention to use GIT.

Hypothesis 6. Conscientiousness Conscientiousness moderates the strength of effect between perceived behavioural control and intention to use GIT.

Theoretical framework

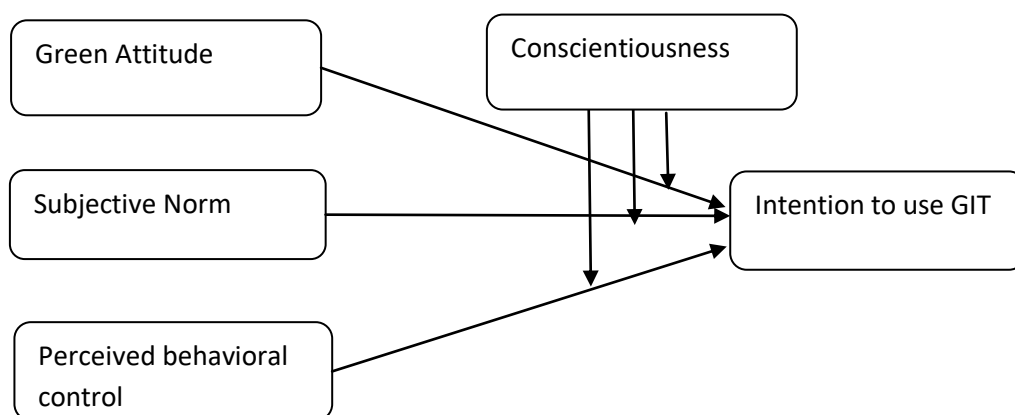

Fig.1:Theoretical framework

METHODOLOGY

Measures

Items used in present study to measure the variables adopted from the literature. A seven-point Likert scale was employed to measure all items where 1 representing the "strongly disagree" and 7 depicting the "strongly agree".

Sample and data collection

The present study population consists of students studying in higher education institutes of Pakistan familiar with green information technology. Respondents were filtered based on their familiarity with green information technology usage in their daily campus activities. The ninety-eight sample size was sufficient, calculated through G*POWER. However, considering the low response rate in Pakistan, 300 questionnaires were distributed, and 235 responses were recorded. 205 responses were forward for further statistical analysis as 30 were neglected due to partially filled. Table 1 reflects that male were major among respondents (66%), aged 18-22 (41%), and having graduation qualifications.

Table 1: Demographic attributes of respondents

	Frequency	Percent (%)
Gender		
Male	134	66
Female	71	34
Age		
18-22	85	41
23-25	68	34
25-35	37	18
More than 35	15	7
Education		
Graduation	124	61
Master	47	23
MPhil/MS	28	14
PhD	6	2

Data Analysis

The data were analyzed using the partial least squares structural equation modelling (PLS-SEM) technique. The SmartPLS 3.0 software was used to statistically assess the hypotheses. A two-stage analysis approach was followed. The current study applied the bootstrapping procedure to determine the developed hypotheses, and normalization of data is not a pre-requisite in PLS-SEM. It relies on bootstrapping for checking the significance of path coefficients.

ANALYSIS AND RESULTS

Measurement model assessment

The measurement model used to assess the present study's reliability and validity using the approach recommended by Hair et al. (2013) for reflective constructs. The results of the measurement model depicted in Table 2. The results show that the items are well-developed and valid for further statistical analysis.

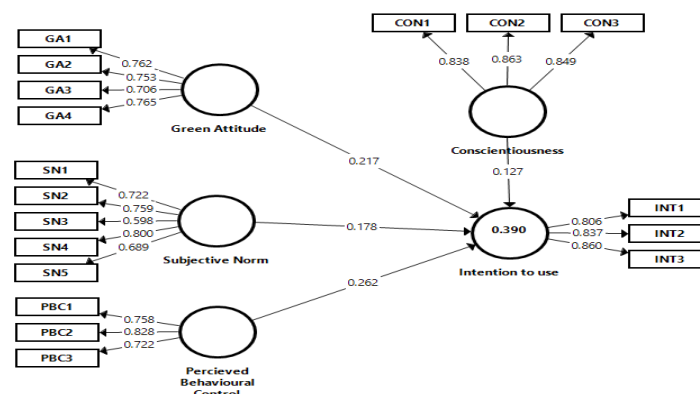

Fig.2: PLS Algorithm Assessment (Main effect Model)

The value of R^2 is 0.390, as shown in Figure 2, which depicts that all exogenous variables, including green attitude, subjective norm, perceived behavioural control, and the moderator variable conscientiousness, explain 39% variance in intention to use green information technology. Then after included interaction terms and PLS algorithm value of R^2 is 0.419 in Figure 3 in the interaction effect model. The change in R^2 is 0.029 that indicated 2.9% additional variance with the addition of interaction terms, which depicts a small effect size f^2 value of 0.0290, stated by Cohen (1988).

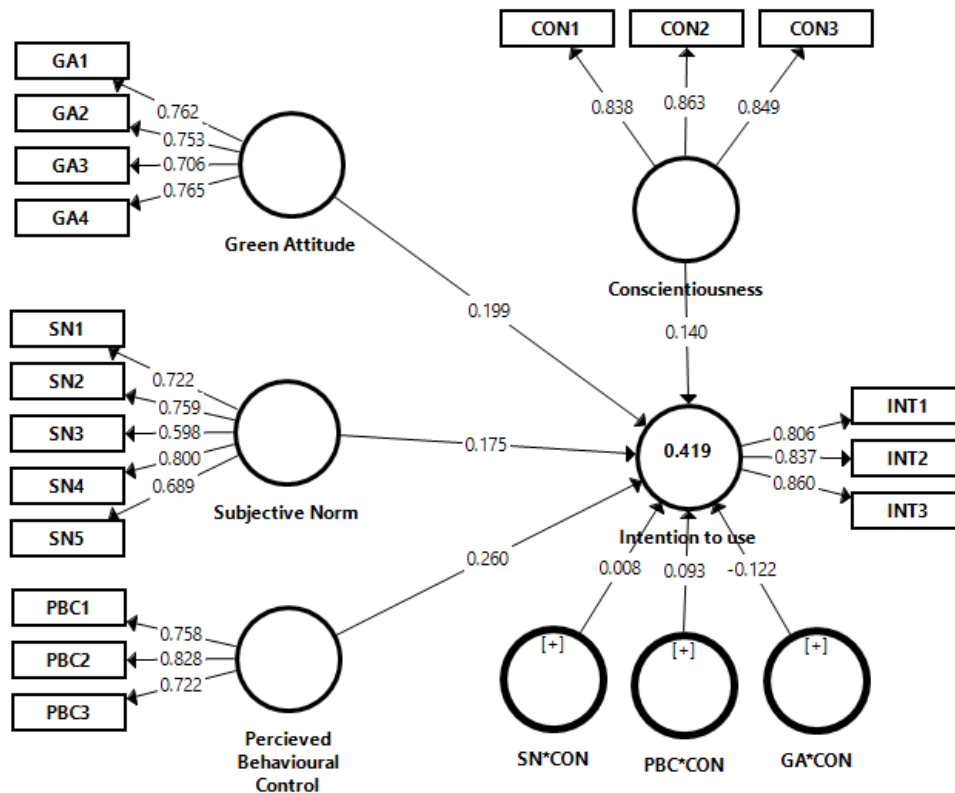

Fig.3: PLS Algorithm Assessment (Interaction effect Model)

The values of loadings of items associated with a construct determine either the measurement model is suitable to carry for further analysis or not (Hair Jr et al., 2020). Internal reliability and consistency are assessed using composite reliability (CR) and average variance extracted (AVE) of the constructs. The value of AVE should be more than 0.5 (Vinzi et al., 2010). When there is AVE's problem, the items having fewer loadings should be discarded (Hair et al., 2014). AVE's values for all the constructs were more than 0.5 (for Conscientiousness 0.722, Green Attitude 0.558, intention to use 0.697, Perceived behavioural control 0.594, and Subjective Norm 0.514).

Table 2: Constructs' validity and reliability

Constructs	Items	Loadings	CR	AVE
Conscientiousness (CON)	CON1	0.838	0.886	0.722
	CON2	0.863		
	CON3	0.849		
Green Attitude (GA)	GA1	0.762	0.834	0.558
	GA2	0.753		
	GA3	0.706		
Intention to use (INT)	INT1	0.806	0.873	0.697
	INT2	0.837		
	INT3	0.860		

Perceived behavioural control (PBC)	PBC1	0.758	0.814	0.594
	PBC2	0.828		
	PBC3	0.722		
Subjective Norm (SN)	SN1	0.722	0.840	0.514
	SN2	0.759		
	SN3	0.598		
	SN4	0.800		
	SN5	0.689		

CR= Composite reliability; AVE = Average variance extracted

Table 3 depicts results of discriminant validity using (Fornell & Larcker, 1981) method. All diagonal values .850, 0.747, 0.835, 0.770, and 0.717 are greater than other values that confirm the discriminant validity of constructs.

Table 3: Discriminant Validity (Fornell-Larker)

	CON	GA	INT	PBC	SN
Conscientiousness (Con)	0.850				
Green Attitude (GA)	0.478	0.747			
Intention to use (INT)	0.477	0.509	0.835		
Perceived Behavioural Control (PBC)	0.598	0.482	0.537	0.770	
Subjective Norm (SN)	0.502	0.590	0.509	0.531	0.717

Structural model assessment

To evaluate the direct relationships, structural model/inner model assessment is used. Path coefficient and t-values are assessed to evaluate the structural model. T-value greater than 1.64, indicated the acceptance of the proposed hypothesis. Out of three hypotheses that proposed direct relationships, all were supported. Figure 4 represents the general structural model assessment results of direct effects hypotheses.

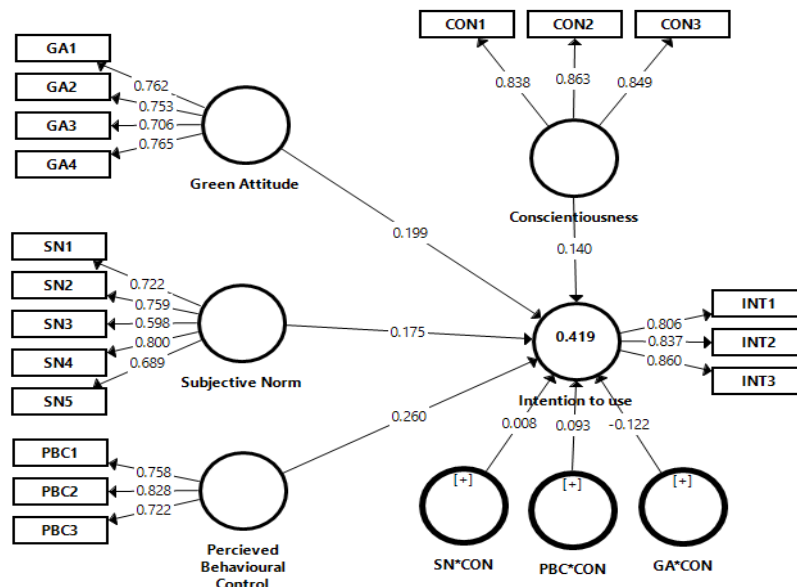

Fig.4: PLS Algorithm Assessment (Interaction effect Model)

The results in Table 4 revealed the acceptance of the H1 hypothesis that green attitude positively predicts intention to use green information technology. The hypothesis H2 also supported, as depicted in Table 4 that subjective norm has a significant favourable influence on intention to use green information technology. The numbers in Table 4 also show the acceptance of hypothesis H3 that perceived behavioural control has a significant positive effect on using green information technology.

Table 4: Structural model Assessment (Direct relationships)

Hypothesis	Relationships	Std. Beta	Std. Error	T Value	P Value	Decision
H1	GA -> INT	0.199	0.074	2.687	0.004	Supported
H2	SN -> INT	0.175	0.071	2.478	0.007	Supported
H3	PBC-> INT	0.260	0.071	3.678	0.000	Supported

Moderating effect assessment

The current study deployed a product indicator approach suggested by Hair Jr et al. (2020) to measure the moderating effect by creating interaction terms of moderating variable conscientiousness with green attitude, subjective norm and perceived behaviour control. The results in Table 5 and Figure 5 indicated that hypothesis H4 supported stating that conscientiousness strengthens the effect between green attitude and intention to use green information technology. In contrast, H5 and H6 were not supported, having P values greater than 0.05, as mentioned in Table 5, Figure 6 and 7.

Table 5: Moderating effects assessments

Hypothesis	Relationships	Std. Beta	Std. Error	T Value	P Value	Decision
H4	GA*CON -> INT	-0.122	0.070	1.739	0.040	Supported
H5	SN*CON -> INT	0.008	0.071	0.108	0.457	Not Supported
H6	PBC*CON -> INT	0.093	0.078	1.198	0.116	Not Supported

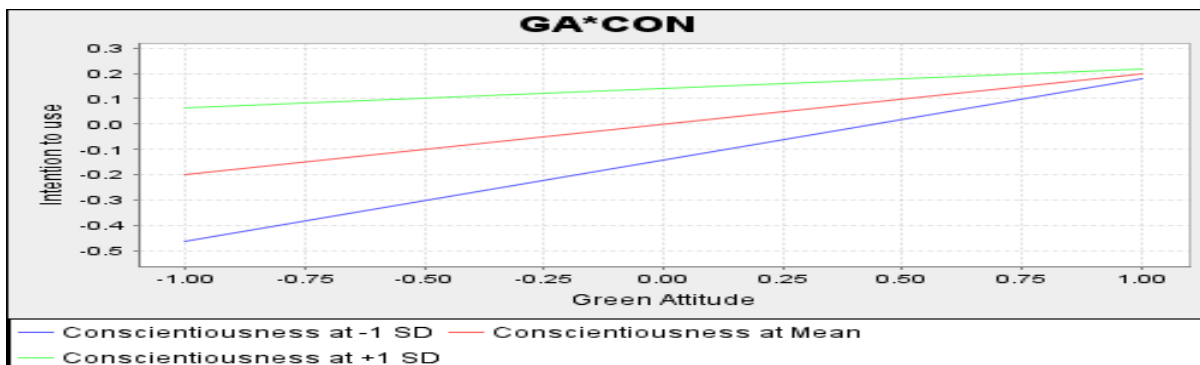

Fig.5: PLS Algorithm Assessment (Interaction effect Model)

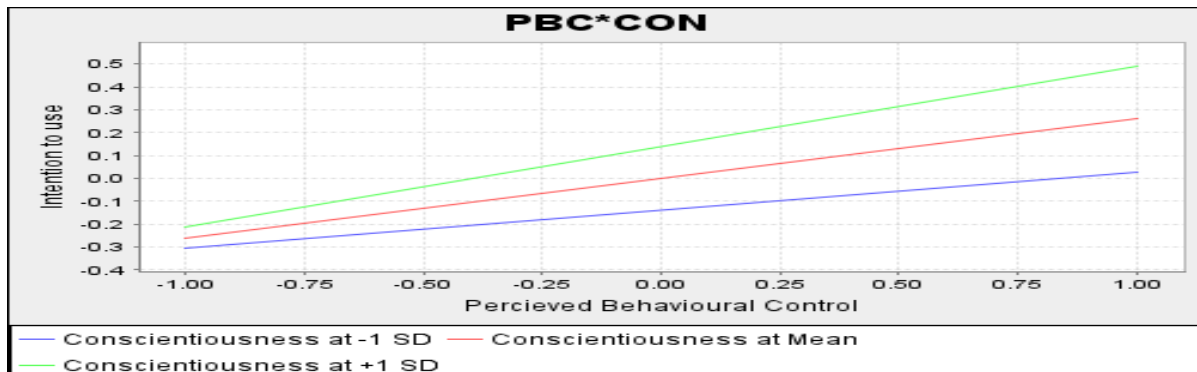

Fig.6: PLS Algorithm Assessment (Interaction effect Model)

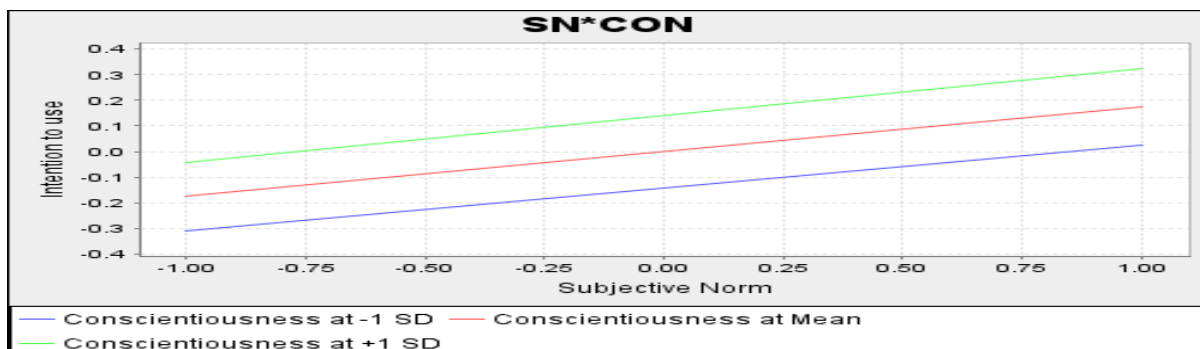

Fig.7: PLS Algorithm Assessment (Interaction effect Model)

DISCUSSION

The current study utilizes the theory of planned behaviour (TPB) to analyze the influence of Green attitude, Subjective Norm, and perceived behaviour control on the behavioural intention to use GIT and then moderating effect of personality trait conscientiousness. There was a total of six hypotheses developed for assessment. Out of six, there are three direct hypotheses. Three were moderating hypotheses that measure the moderating impact of personality trait conscientiousness between Green attitude, Subjective Norm, perceived behaviour control and intention to use GIT.

The current study shows that green attitude has a significant impact on intention to use green information technology. Existing literature also witnessed the same result (Khan & Qianli, 2017). The result appearance that subjective norms have a significant impact on intention to use green information technology. The result is consistent with the existing Literature (Shabbir et al., 2020). The current study's development depicted that perceived behaviour control significantly impact the intention to use green information technology. The result is consistent with extant Literature (Linehan & Fisher, 2018).

There are three moderating hypotheses related to the moderating impact of personality trait conscientiousness between independent variables and intention to use green information technology. The current study shows that conscientiousness positively moderates the relationship between green attitude and intention to use green information technology. Existing literature also witnessed the same result (Salloum et al., 2019). Results showed that conscientiousness has no moderating effect between the relationships of subjective norm and perceived behavioural control with the intention to use green information technology.

THEORETICAL AND PRACTICAL IMPLICATIONS OF THE STUDY

The present study is one of the few empirical studies investigating the level of intention to use GIT among students in higher education institutes. The contributions of current research are twofold. Theoretically, the study's findings contribute to the literature by examining the moderating impact of personality traits on the individual's behavioural intention to use GIT. Secondly, current research collected data from students at developing country's higher education institutes who are more exposed to ICT, especially during the pandemic of COVID-19.

The study's practical contributions include delivering guidelines to decision-makers and administration of the higher education institutes to consider the personality trait conscientiousness through self-discipline and self-efficacy among students to reshape their behaviours towards environmental sustainability. The level of awareness about eco-sustainability can enhance through seminars, tailor proposals, green campaigns that make students' positive attitude to reduce the emission of electronic wastage in the environment and protect natural resources' depletion.

CONCLUSIONS

The present research has extended the TPB theory by analyzing the moderating role of personality trait conscientiousness on the GIT usage behaviour of Pakistan students at higher education institutes. The results revealed that students' positive attitude strongly determines the intention to use GIT as they have positive feelings to use IT items in an eco-friendly way. The perceived behaviour control has also found a significant role in the higher intention to use GIT among students. The social norm findings also depicted that societal pressure impacts student's beliefs and values that lead towards the higher usage of GIT in higher education institutes.

The current study has certain limitations. First, data collected from Pakistani higher education institutes. Future researchers can consider data collection from another country for better generalizability. Second, the present research only considers the single data collection method survey conducted through a close-ended questionnaire. Future studies may apply a mixed data collection method using interviews for in-depth findings. Moreover, the current investigation utilizes only conscientiousness as the moderating variable to examine the intention to use GIT among students. The future researcher can use other personality trait variables as moderators.

REFERENCES

1. Al-Ghazali, B. M., & Afsar, B. (2021). Retracted: Green human resource management and employees' green creativity: The roles of green behavioral intention and individual green values. *Corporate Social Responsibility and Environmental Management*, 28(1), 536–536.
2. Chih-Lin, I., Han, S., & Bian, S. (2020). Energy-efficient 5G for a greener future. *Nature Electronics*, 3(4), 182–184.
3. Dalvi-Esfahani, M., Alaedini, Z., Nilashi, M., Samad, S., Asadi, S., & Mohammadi, M. (2020). Students' green information technology behavior: Beliefs and personality traits. *Journal of Cleaner Production*, 257, 120406.
4. Fornel, C., & Larcker, D. F. (1981). Evaluating Structural Equation Models with Unobservable Variables and Measurement Error: Algebra and statistics (Vol. 18, Issue 1, pp. 39–50).

5. Fu, X. (2021). A novel perspective to enhance the role of TPB in predicting green travel: The moderation of affective-cognitive congruence of attitudes. *Transportation*, 1–23.
6. Gill, A. A., Malik, S., Iqbal, S., Haseeb, H., & Akhtar, N. (2020). AN EMPIRICAL STUDY OF HIGHER EDUCATION STUDENTS'INTENTIONS TO USE E-LEARNING: DEVELOPING COUNTRY PERSPECTIVE. *PalArch's Journal of Archaeology of Egypt/Egyptology*, 17(8), 1046–1058.
7. Gill, A., Ahmad, B., & Kazmi, S. (2021). The effect of green human resource management on environmental performance: The mediating role of employee eco-friendly behavior. *Management Science Letters*, 11(6), 1725–1736.
8. Habib, M. N., Khalil, U., Khan, Z., & Zahid, M. (2021). Sustainability in higher education: What is happening in Pakistan? *International Journal of Sustainability in Higher Education*.
9. Hagger, M. S., & Hamilton, K. (2021). Effects of socio-structural variables in the theory of planned behavior: A mediation model in multiple samples and behaviors. *Psychology & Health*, 36(3), 307–333.
10. Hair, J. F., Sarstedt, M., Hopkins, L., & Kuppelwieser, V. G. (2014). Partial least squares structural equation modeling (PLS-SEM): An emerging tool in business research. In *European Business Review*. <https://doi.org/10.1108/EBR-10-2013-0128>
11. Hair Jr, J. F., Howard, M. C., & Nitzl, C. (2020). Assessing measurement model quality in PLS-SEM using confirmatory composite analysis. *Journal of Business Research*, 109, 101–110.
12. Hernandez, A. A. (2020). Exploring the factors to green IT adoption of SMEs in the Philippines. In *Start-Ups and SMEs: Concepts, Methodologies, Tools, and Applications* (pp. 907–926). IGI Global.
13. Khan, S. A. R., & Qianli, D. (2017). Impact of green supply chain management practices on firms' performance: An empirical study from the perspective of Pakistan. *Environmental Science and Pollution Research*, 24(20), 16829–16844.
14. Lee, H., Choi, Y., Van Nguyen, T., Hai, Y., Kim, J., Bahja, M., & Hocaoğlu, H. (2020). COVID19 Led Virtualization: Green Data Center for Information Systems Research. *Information Systems Management*, 37(4), 272–276.
15. Li, W., Bhutto, T. A., Xuhui, W., Maitlo, Q., Zafar, A. U., & Bhutto, N. A. (2020). Unlocking employees' green creativity: The effects of green transformational leadership, green intrinsic, and extrinsic motivation. *Journal of Cleaner Production*, 255, 120229.
16. Linehan, M., & Fisher, C. (2018). Green IT: Hofstra University's Information Technology Upgrades Created Unplanned Sustainable “Green Benefits” by Increasing Efficiency and Reducing Costs. In *The Palgrave Handbook of Sustainability* (pp. 615–632). Springer.
17. Muniswamaiah, M., Agerwala, T., & Tappert, C. C. (2020). Green computing for Internet of Things. 182–185.
18. Nizam, H. A., Zaman, K., Khan, K. B., Batool, R., Khurshid, M. A., Shoukry, A. M., Sharkawy, M. A., Aldeek, F., Khader, J., & Gani, S. (2020). Achieving environmental sustainability through information technology: “Digital Pakistan” initiative for green development. *Environmental Science and Pollution Research*, 1–16.
19. Qazi, W., Qureshi, J. A., Raza, S. A., Khan, K. A., & Qureshi, M. A. (2020). Impact of personality traits and university green entrepreneurial support on students' green entrepreneurial intentions: The moderating role of environmental values. *Journal of Applied Research in Higher Education*.
20. Salloum, S. A., Alhamad, A. Q. M., Al-Emran, M., Monem, A. A., & Shaalan, K. (2019). Exploring students' acceptance of e-learning through the development of a comprehensive technology acceptance model. *IEEE Access*, 7, 128445–128462.
21. Sethi, V., & Jain, A. (2020). The role of subjective norms in purchase behaviour of green FMCG products. *International Journal of Technology Transfer and Commercialisation*, 17(2–3), 219–241.
22. Shabbir, M. S., Bait Ali Sulaiman, M. A., Hasan Al-Kumaim, N., Mahmood, A., & Abbas, M. (2020). Green Marketing Approaches and Their Impact on Consumer Behavior towards the Environment—A Study from the UAE. *Sustainability*, 12(21), 8977.
23. Shahzad, F., Du, J., Khan, I., Shahbaz, M., Murad, M., & Khan, M. A. S. (2020). Untangling the influence of organizational compatibility on green supply chain management efforts to boost organizational performance through information technology capabilities. *Journal of Cleaner Production*, 266, 120229.
24. Thabit, T., Aissa, S. A. H., & Jasim, Y. (2021). The Impact of Green ICT Adoption in Organizations of Developing Countries. *Al-Riyada for Business Economics Journal*, 7.
25. Vinzi, V. E., Trinchera, L., & Amato, S. (2010). Handbook of Partial Least Squares. In *Handbook of Partial Least Squares* (pp. 47–82). <https://doi.org/10.1007/978-3-540-32827-8>
26. Wang, Y.-Y., Wang, Y.-S., & Wang, Y.-M. (2020). What drives students' Internet ethical behaviour: An integrated model of the theory of planned behaviour, personality, and Internet ethics education. *Behaviour & Information Technology*, 1–23.
27. Yarimoglu, E., & Gunay, T. (2020). The extended theory of planned behavior in Turkish customers' intentions to visit green hotels. *Business Strategy and the Environment*, 29(3), 1097–1108.

Dr. Atif Ali Gill et al/ Examine the individual's behavioural intentions to use Green Information technology: Moderating role of personality trait conscientiousness

28. Zhang, Y., Sun, J., Yang, Z., & Wang, Y. (2020). Critical success factors of green innovation: Technology, organization and environment readiness. *Journal of Cleaner Production*, 264, 121701.